

MESA/BOOGIE[®]

SUBWAY[®]
BASS DI-PREAMP

Owner's Manual

Greetings from the Home of Tone®

...You, smart player and intuitive human, have put your trust in us to be your amplifier company. This is something that we do not take lightly. By choosing this instrument to be part of your musical voice, you have become part of the MESA® family... WELCOME!

Our goal is to never let you down. Your reward is that you are the new owner of an amp, bred of fine heritage, benefitting from the many pioneering and patented MESA circuits as well as fresh cutting edge research and development efforts, leading to this new and exciting model. We feel confident that this amp will inspire many hours of musical satisfaction and lasting enjoyment. It was built with you in mind, by players who know the value of a fine musical instrument and the commitment it takes to make great music. The same commitment to quality, value and support we make to you... our new friend.

SUBWAY[®]

BASS DI-PREAMP

Table of Contents

PRECAUTIONS AND SAFETY INSTRUCTIONS	
OVERVIEW _____	1

TOP PANEL (CONTROLS & FEATURES)

INPUT JACK _____	2
THRU OUTPUT JACK _____	2
DEEP SWITCH _____	2
ACTIVE/PASSIVE SWITCH _____	2
HIGH PASS FILTER _____	2
INPUT (GAIN) CONTROL _____	3
VOICING CONTROL _____	3
BASS CONTROL _____	3
LOW MID CONTROL _____	3
HIGH MID CONTROL _____	3
TREBLE CONTROL _____	3
MASTER VOLUME CONTROL _____	3
POWER LED _____	3

REAR PANEL (CONTROLS & FEATURES)

POWER JACK _____	4
OPERATING POWER REQUIREMENTS _____	4
PREAMP OUT XLR JACK _____	4
PREAMP OUT GROUND LIFT SWITCH _____	4-5
PREAMP OUT ¼" (6.3mm) JACK) _____	5
DIRECT OUT XLR JACK _____	5
DIRECT OUT GROUND LIFT SWITCH _____	5
DI OUT SOURCE SWITCH _____	5

TROUBLESHOOTING _____	6-7
FACTORY SAMPLE SETTINGS _____	8
USER SETTINGS _____	9
SPECIFICATIONS _____	10
BLOCK DIAGRAM _____	11

IMPORTANT SAFETY INSTRUCTIONS

- Read, keep and follow these instructions.
- Heed all warnings.
- Do not use this apparatus near water.
- Clean only with dry cloth.
- Use only with approved AC (mains) power adapters.
- Protect any power cords from being walked on or pinched, particularly at plugs, receptacles, and the point where they exit from the apparatus.
- Unplug this apparatus during lightning storms or when unused for long periods of time.
- Refer all servicing to qualified service personnel. Servicing is required when the apparatus has been damaged in any way, such as liquid has been spilled or objects have fallen into the apparatus, the apparatus has been exposed to rain or moisture, does not operate normally, or has been dropped.
- No naked flame sources, such as lighted candles, should be placed on the apparatus.
- The apparatus shall not be exposed to dripping or splashing and no objects filled with liquids, such as drinks or vases, shall be placed on the apparatus.
- **WARNING:** To reduce the risk of fire or electric shock, do not expose this apparatus to rain or moisture.
- To avoid damaging your speakers and other playback equipment, turn off the power of all related equipment before making the connections.
- Do not use excessive force when handling buttons, switches and controls. Do not use solvents such as benzene or paint thinner to clean the unit.
- Only connect to an AC power supply adapter that meets the power supply specifications listed on the rear of the unit. Make certain grounding/earthing conforms with local standards.

*Your MESA/Boogie® SUBWAY® BASS DI-PREAMP is a professional instrument.
Please treat it with respect and operate it properly.*

SUBWAY® BASS DI-PREAMP

Operating Instructions

Overview

Congratulations on your choice of the SUBWAY® BASS DI-PREAMP and welcome to the MESA/Boogie® family! First, we would like to thank you for choosing us as your amplifier company and trusting us to help create your musical voice. This is something we never take for granted, and you'll find that we are here and ready to assist you should you ever need help. Our goal is to help you sound your best at all times! We feel confident that your new Bass DI-PREAMP will bring you many years of reliable service, rewarding inspiration and create for you a newfound freedom to express your music.

You have chosen a Bass DI-PREAMP bred of a fine heritage, and this model is our testament to our legacy of tone. Its forefathers can be traced back to the very first MESA amplifier ever built, the MESA 450 Bass Head. In fact, the first 5 MESA amplifiers built in the Lagunitas mountain shack were Bass amps...a piece of trivia little known and overshadowed by our overwhelming notoriety for guitar amplification. But we've always loved the Bass, and have—since day one—been committed to elevating its stature through our art form. The bloodline for MESA bass continued with the first rack-mount chassis bass amplifier in 1980, the D-180. The mid-eighties saw the introduction of the BASS 400 and later in 1988, the BASS 400+ with its stunning Pitch, Punch and Power delivered by an additional 6 x 6L6s to bring the total to twelve 6L6s in the mighty power section.

The 400+ went on to become a classic used by the world's most talented bassists for two decades. Paul McCartney, Mark King, Stanley Clark, Jack Blades, Michael Anthony, Blasko and Bootsy Collins, are but a few of the international stars that put the 400+ center stage to anchor the band during its 20 year build cycle. Those iconic amps still bring top dollar when you can find one changing hands on the pre-owned market.

Tone Freaks seeking a versatile & compact preamp solution for multiple pro applications - Rejoice! The SUBWAY Bass DI-PREAMP is the next step in the MESA Bass Bloodline. The Subway preamp circuit has established itself as a perfect balance of tone and functionality for all players and styles. That exact preamp circuit is now packaged in a portable, studio quality D.I. format with an innovative and complete feature set to cover practically any gigging, rigging and studio application you can dream of. The thoughtful I/O and layout makes the Subway D.I. Pre a swiss-army knife for world-class bass tone in any application. The SUBWAY® BASS DI-PREAMP is built in Petaluma, CA with the World's Finest Materials.

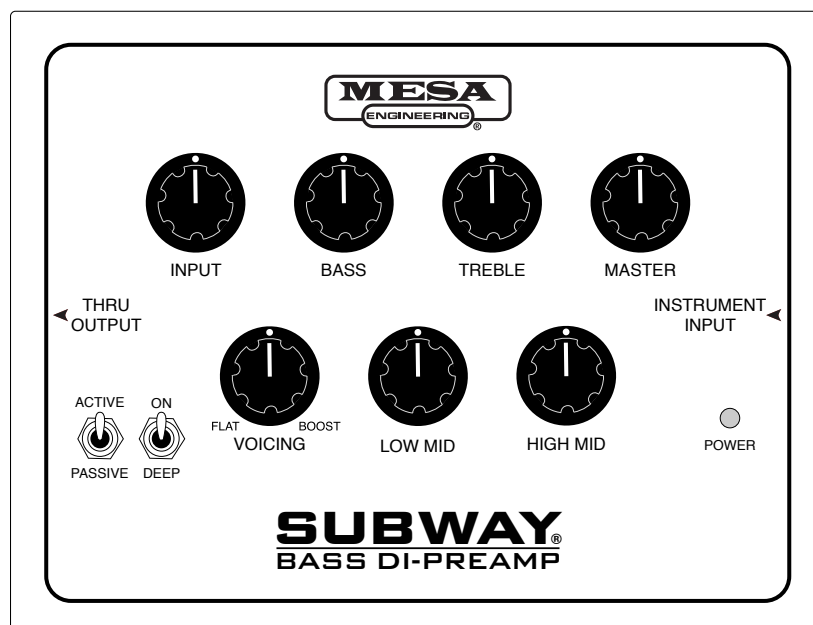

TOP PANEL (CONTROLS & FEATURES)

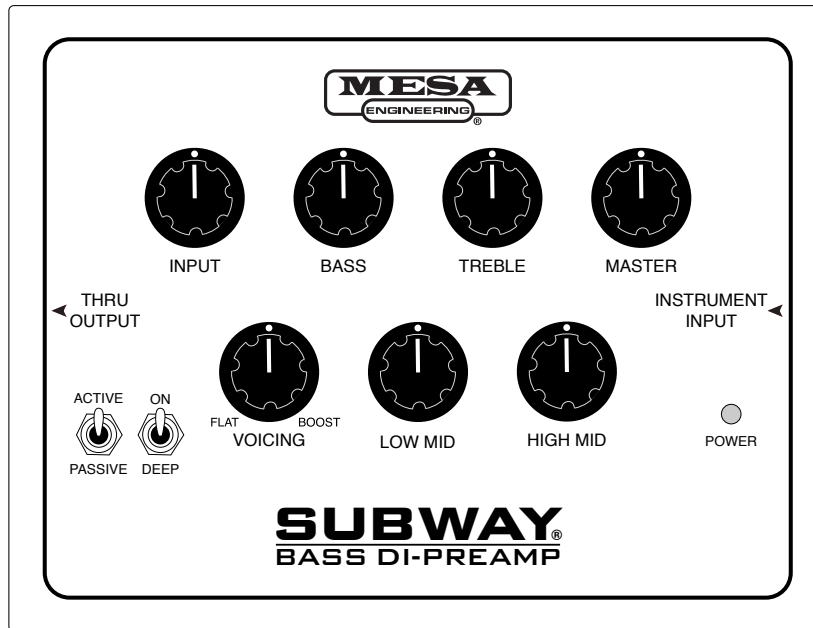

INPUT JACK This jack (located on the right side of the chassis) is the instrument INPUT that feeds the first stage monolithic J-FET buffer amp of the SUBWAY BASS DI-PREAMP. The input sensitivity of this input buffer amp is adjustable with the ACTIVE/PASSIVE switch, the active position being about 10dB less sensitive (lower gain) than the passive position. When a 1/4" (6.3mm) plug is inserted into the jack, the power is automatically turned on, but please note that it is important for the 1/4" (6.3mm) plug to be of the TIP-SLEEVE type as TIP-RING-SLEEVE types may not engage the turn-on circuit properly. It is always good practice (and customary) to inform the FOH/monitor engineer that you will be turning your PRE-DI on or off so as to prevent any pops or unexpected signal into their system(s).

THRU OUTPUT JACK This jack (located on the left side of the chassis) is the instrument THRU OUTPUT that is parallel to the input jack. This signal is identical to (and not isolated from) the signal from the bass itself. It is not a buffered output, and would typically be used to feed the instrument input of a stage amp.

DEEP SWITCH This switch engages the DEEP filter, our take on classic low frequency response enhancement and extension. Engaged, there is a mild boost in the very low frequency response while also lowering the effective high pass filter frequency. This combination brings a more round, thicker, fatter response to the bottom end. When using this preamp with small (compact style) cabinets, and especially with large amounts of bass eq boost, be aware of the possibility of damage due to overpowering at higher volumes.

ACTIVE/PASSIVE SWITCH This switch sets the sensitivity of the J-FET input buffer. Often (though not always), an active bass may have a signal level up to 10dB greater than a typical passive bass. If you find that you are operating the gain control near the low end of the control's rotation in order to prevent the O/L LED from flashing, switching this switch up (into the ACTIVE position) will reduce the input sensitivity (gain) by ~10dB, allowing greater control range and freedom from overload with high output active basses.

HIGH PASS FILTER While not a visible switch or control, it is an important internal feature in maintaining control over the extreme low end, especially under high drive conditions. This precision 4 pole filter has a turnover frequency that is set at approximately 30Hz with minimal ripple response. While HPF's have been standard fare within the pro audio industry for decades, this feature has only appeared in bass guitar amplifiers within the past few years (with a few notable exceptions). This filter also provides additional mechanical protection to the speakers by limiting the power to the speaker below the frequency range that the speaker cabinet cannot provide adequate acoustic loading to the drivers. This is one of the primary (and preventable) causes of premature speaker failure, especially with compact speaker cabinet products.

INPUT (GAIN) CONTROL This control determines the input gain of the first gain stage and thus the level that the following electronics stages operate at. Overdriving the input gain stage may be a desirable tonal characteristic of your playing style. When using significant overdriven tones, you may find it helpful to back down on the TREBLE EQ a little bit to reduce harshness and also to reduce the BASS EQ to increase the clarity and impact.

VOICING CONTROL This active EQ control modifies the amplifier's response from a more flat like curve (in the counter-clockwise position) to a more vintage curve (in the clockwise position) by modifying and shifting the frequency response in all regions with a simple turn of the knob. As the control is rotated clockwise, the low end increases and the high end increases while the midrange decreases and shifts upward. Common uses for the more vintage positions are the old school funk and slap tones, and rock tones where a rounder bottom and a little bite are needed. Experimentation is an important part of discovering the potential of this powerful tool. To initially set up your sound, gradually rotate the VOICING control clockwise towards the vintage position and stop when you achieve the basic amp voicing that you are looking for. The more clockwise, the greater the low end boost, mid cut (frequency also shifts as the control is rotated) and a mild treble boost. With your fundamental tone 'roughed in' via the VOICING control, the EQ (BASS, LO MID, HI MID & TREBLE) delivers the tools for polished tone shaping.

BASS CONTROL This active EQ control is responsible for the amount of low frequencies present in the signal, relative to the rest of the spectrum. Low frequencies (<80Hz) are responsible for the "bottom", "roundness", or "feel" of the tone. This is an active control with boost and cut, the amount of boost proportional to the clockwise rotation to the right of "flat" (12:00 straight up) position and the amount of cut proportional to the counter-clockwise rotation to the left of "flat" (12:00 straight up) position. As with everything related to EQ, generally, a little bit goes a long way. Use enough to get the job done and no more. Note that if you have very compact cabinets and need high volumes, you will want to be aware that it is possible to overdrive speakers with excessive bass boost. If your speaker is not getting you enough high level low end, it's also possible that you do not have enough "rig for the gig", and "more speaker" is needed. This is a shelving style filter.

LOW MID CONTROL This active EQ control is responsible for the amount of low midrange frequencies present in the signal, relative to the rest of the spectrum. Low mid frequencies (centered at 200Hz) are responsible for the "earthy", "woody" character of the tone. This is an active control with boost and cut, the amount of boost proportional to the clockwise rotation to the right of "flat" (12:00 straight up) position and the amount of cut proportional to the counter-clockwise rotation to the left of "flat" (12:00 straight up) position. This is a peak-dip (or bell) style filter.

HIGH MID CONTROL This active EQ control is responsible for the amount of high midrange frequencies present in the signal, relative to the rest of the spectrum. High mid frequencies (centered at 480Hz) are responsible for the "boxy", "barky" character of the tone. This is an active control with boost and cut, the amount of boost proportional to the clockwise rotation to the right of "flat" (12:00 straight up) position and the amount of cut proportional to the counter-clockwise rotation to the left of "flat" (12:00 straight up) position. This is a peak-dip (or bell) style filter.

TREBLE CONTROL This active EQ control is responsible for the amount of high frequencies present in the signal, relative to the rest of the spectrum. High mid frequencies (>2.5kHz) are responsible for the "bright", "airy", "shimmery" character of the tone. This is an active control with boost and cut, the amount of boost proportional to the clockwise rotation to the right of "flat" (12:00 straight up) position and the amount of cut proportional to the counter-clockwise rotation to the left of "flat" (12:00 straight up) position. This is a shelving style filter.

MASTER VOLUME CONTROL This control is responsible for the level of signal being sent to the PREAMP OUTPUT jack, and determines the overall playing volume of the SUBWAY BASS DI-PREAMP. Using the MASTER VOLUME along with the INPUT GAIN control allows the optimal control over playing volume. For example, if you are using high input gain to achieve an overdriven tone, it will be likely be necessary to adjust the master volume down to obtain a reasonable playing volume and to avoid excessive overdriving of the power amp. Likewise, if you are looking for a very clean tone, you may wish to start with a lower INPUT GAIN control setting and use a higher MASTER VOLUME control setting to obtain the desired playing volume.

POWER LED This blue LED indicates that the DI-PREAMP is connected to a power source and is switched on, operating correctly.

REAR PANEL (CONTROLS & FEATURES)

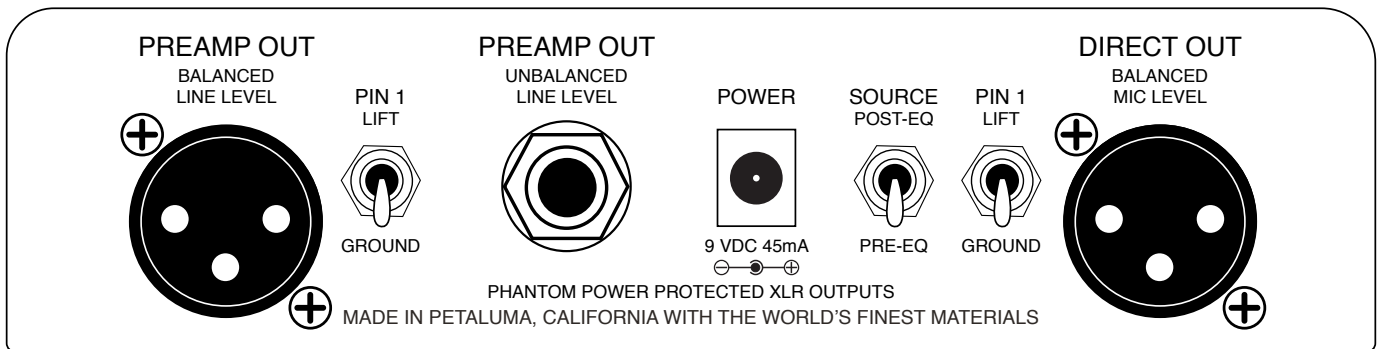

POWER JACK The SUBWAY BASS DI-PREAMP is designed to operate from any standard 9VDC, center “-“ (minus) power supply using a standard 2.1mm center pin and 5.5mm outside barrel. While the DI PREAMP itself is tolerant of noise from outside power supplies, inadvertent ground loops can be created between pedals and devices connected before and after the SUBWAY DI-PREAMP. In the event that noise is encountered, start with powering the DI-PREAMP first, then add pedals, one at a time, noting which pedal is responsible for introducing the noise.

OPERATING POWER REQUIREMENTS The SUBWAY BASS DI-PREAMP is designed to operate from either its internal 9 volt battery (alkaline is recommended), or from any standard 9VDC center “-“ (minus) power supply using a standard 2.1mm center pin and 5.5mm outside barrel. The internal battery may remain in place as there is circuitry present that will automatically select the external DC power supply when present. The internal battery is accessed by removing the cover from the battery box, located on the bottom of the unit. The internal circuitry is protected against accidental battery and external power supply reversed polarity connection attempts. Current requirements of the DI-PREAMP are less than 10mA, resulting in an expected battery life of about 40 hours.

PREAMP OUT XLR JACK This output jack is fully balanced and can deliver a +4dBu (line level) with a maximum output level of about +12dBu, at high MASTER VOLUME settings. The PREAMP OUT is designed to provide ideal compatibility and connectivity to any pro level powered speaker, monitor or powered PA, as well as pro audio power amps (with or without crossovers), external crossovers, and power amps with DSP crossover capabilities. The XLR jacks also make this an ideal Output for connecting to the classic and favored compressors with balanced Inputs that many bassists use in their rigs. Combined with the THRU, 1/4" PREAMP OUT and DIRECT OUT, the SUBWAY DI PREAMP becomes the ultimate swiss-army knife fly rig or backup tool that guarantees getting your familiar tone even when using existing stage monitoring, power amps & cabs or PA systems commonly found at venues. The wide range of connectivity options also makes it invaluable in more advanced rig building applications like bi-amping or multi-amp/cab where unique tones are blended between different preamp, power and cabinet sources. Combined with the DIRECT OUT, the SUBWAY DI is equally useful in multi-input recording applications, providing studio quality Outputs simultaneously for both PRE and POST with GROUND LIFT switches for both. NOTE: When recording multiple PRE and POST sources, phase relationships should always be checked/monitored as the wide range of tone controls possibilities may change the phase from your PRE signal and POST signals. The signal is derived after all voicing and EQ filters as well as after the MASTER VOLUME control. It is also fully phantom power protected, in the event of accidental connection to an input that has phantom power present.

PREAMP OUT GROUND LIFT SWITCH This switch connects or lifts the circuit ground/earth/common connection from pin 1 on the XLR PREAMP OUT connector only. Balanced outputs do not rely on the pin 1 or shield connection to transmit signal to the amplifier. While pin 1 is almost always connected to amplifier's ground bus, often (due to differences in potential of a building's ground/earth system) currents will flow between grounds if there is a common connection, resulting in hum. By lifting the ground at the sending (preamp) end, this allows the shielding to remain in place while breaking the ground current flow that is the cause for

inducing hum into the signal carrying pair of conductors. Now, the one thing that complicates this is that at very high (radio) frequencies, ground is not “really” ground, so additional techniques are incorporated within this network that allows 2 functional grounding spectrums within the same network, providing added RFI (radio frequency interference) rejection. The general rule is to start with pin 1 lifted, and if there is noise, then try connecting it. It should also be noted that there are a lot of other possible causes for noise; this switch is a solution for ground loop noise between the preamp and the power amp.

PREAMP OUT ¼” (6.3mm) JACK This output jack is unbalanced and can deliver a +4dBu (line level) with a maximum output level of about +6dBu with high MASTER VOLUME settings. This unbalanced, post-tone control Output is optimized for connections to MI amplifier ‘Power Amp In’ or FX loop RETURN jacks (bypassing the amp’s preamp and EQ), and is also suitable for connection to MI amplifier Inputs. Combined with the XLR PREAMP OUTPUTS and the 1/4” THRU, the SUBWAY DI-PREAMP can become a ‘tonal command center’ for additional amplifier/power/cabinet setups in multi-amp or bi-amp rigs. While this output is phantom power protected, it is unlikely that phantom power is ever encountered on a ¼” (6.3mm) input as this violates industry standards.

DIRECT OUT XLR JACK This output jack is fully balanced and delivers a -30dBu (microphone level) with a maximum output level of about -10dBu at higher MASTER VOLUME settings. This studio quality DIRECT OUT has been meticulously designed for optimum low noise and offers the renowned and player-tested and approved SUBWAY Preamp tone and from the D-800 in the compact format. While many D.I. OUTPUTS from products over the years cause Front of House, monitor and studio engineers to frown when a bassists suggests that their D.I. sounds great and isn’t noisy, with the SUBWAY BASS DI PREAMP DIRECT OUT, you can confidently insist they try it and watch them smile as they raise your levels into the mix for the first time. Put your favorite or newfound engineers to the ‘SUBWAY D.I. Challenge’ and let us know how frequently you’ll hear, “that’s one of the best D.I.s I’ve ever heard.”. It is also fully phantom power protected, in the event of accidental connection to an input that has phantom power present.

DIRECT OUT GROUND LIFT SWITCH This switch connects or lifts the circuit ground/earth/common connection from pin 1 on the XLR DIRECT OUT connector only. Balanced outputs do not rely on the pin 1 or shield connection to transmit signal to the audio console. While pin 1 is always connected to console’s ground bus, often (due to differences in potential of a building’s ground/earth system) currents will flow between grounds if there is a common connection, resulting in hum. By lifting the ground at the sending (preamp) end, this allows the shielding to remain in place while breaking the ground current flow that is the cause for inducing hum into the signal carrying pair of conductors. Now, the one thing that complicates this is that at very high (radio) frequencies, ground is not “really” ground, so additional techniques are incorporated within this network that allows 2 functional grounding spectrums within the same network, providing added RFI (radio frequency interference) rejection. The general rule is to start with pin 1 lifted, and if there is noise; then try connecting it. It should also be noted that there are a lot of other possible causes for noise, this switch is a solution for ground loop noise between the preamp and the console.

DI OUT SOURCE SWITCH This switch selects the signal source routing that is used to derive the DIRECT OUTPUT signal. In the PRE position, the signal is sourced directly from the input buffer (pre gain control) and the ACTIVE/PASSIVE switch sets the basic operating gain to provide a more uniform signal level to the DI OUTPUT signal. In the POST position, the signal is sourced from the output of the 4 band equalizer and before the MASTER VOLUME control. For PA use, the FOH (Front of House) engineer will probably prefer a PRE EQ send because the capability of his PA system may be significantly different than the stage rig. The EQ you use to sound good on stage may not work on a bigger system and in a larger acoustic space than just the stage. It’s excellent courtesy to let your FOH or Monitor engineers know you are set to PRE when encouraging them to consider using your D.I. (and suggesting they will love it’s studio quality, low noise, etc.). This also a great way to make friends with the engineers who will then make your gig sound excellent in both your monitors and in the venue mix! For recording, depending on the tracking goals of the engineer, PRE or POST might be used. Or, as mentioned previously, both signals may be captured, blended and/or isolated in addition to other sources like mic’s on amps, which the SUBWAY BASS D.I. PREAMP is likely also providing the signal. A true swiss-army knife of connectivity and tone!

TROUBLESHOOTING

In the event that your SUBWAY DI-PREAMP appears not to work correctly, often enough the problem is not with the PREAMP-DI, but a related piece of equipment. In this case, it's necessary to take a deliberate, systematic approach to troubleshooting in order to effectively identify and correct the problem. Believe it or not, more often than not, the issue is something else in the rig or system, yet the amplifier is often the first consideration since its function is to amplify. We have seen all of these things below (and more) many times.

SYMPTOM

NO AUDIO OUTPUT

Is the power LED lit?

NO: Possible causes to check in this order are:

1. Verify that the power source is good (if using an external AC powered power supply).
2. If you are using an external supply, verify that it's the correct voltage and polarity and that it's actually plugged into the power source. Also check to be sure it is functioning correctly.
3. If you are using the internal battery, be sure that it is a good battery (ie. fully charged) and that it's actually present (yes, this really does happen)
4. Verify that the input cable you are using is a standard 1/4" (6.3mm) TIP-SLEEVE type. TIP-RING-SLEEVE type cables may fail to turn the unit on under conditions where the ring floats or is not solidly connected to sleeve at the other end.
5. If these do not solve your problem, it's possible that your DI-PREAMP has failed. Call our Customer Service department and we will help you get this resolved.

YES: Possible causes to check in this order are:

1. GAIN and MASTER VOLUME controls must be turned up for the PREAMP OUTPUTS to work.
2. When using the PREAMP OUTPUTS with an external power amp, the power amp's input sensitivity controls must be turned up.
3. Defective bass or cable (test with known good bass and cable)
4. Defective cable to the external device, or defective external device (ie. console, recording interface)
5. There is indeed a problem with your DI-PREAMP. Call our Customer Service department and we will help you get this resolved.

SYMPTOM

DISTORTED AUDIO OUTPUT

1. Defective battery in active bass causing instrument's onboard preamp to distort (replace battery)
2. Defective battery in PREAMP-DI causing preamp's electronics to distort (replace battery)
3. With very hot 18V basses, it's possible to overdrive the DI-PREAMP when in passive mode (switch to active mode)
4. Slightly intermittent cable in some part of the system (this can be an instrument cable, patch cable or XLR cable)
5. Defective or blown speaker(s) in cabinet (test with known good cabinet, repair cabinet as needed)
6. There is indeed a problem with your DI-PREAMP. Call our Customer Service and we will help you get this resolved.

SYMPTOM

NOISE (LOW FREQUENCY HUM) IN AUDIO

1. Defective instrument cable or problem with bass wiring. Plug a very short instrument cable into the instrument input (to turn the DI-PREAMP on), if hum is greatly reduced or eliminated, this means that the noise is entering from outside the DI-PREAMP. Try a known good instrument cable and/or bass).
2. If using the XLR outs, try switching the ground lift switch on those in use to eliminate any inadvertent ground loops between connected devices.
3. Disconnect audio feeds from the DI-PREAMP to the noisy equipment and see if the noise goes away. If it does not, the noise is being generated or introduced external to the DI-PREAMP.
4. If the volume level of the hum changes with position of the bass (rotating or general movement), the problem may be external stray magnetic field present that is coupling into the pickups, especially single coils. Possible causes are large power transformers located near the performance area. If this occurs when you get close to another instrument amp it may be due to stray field from its power supply. Moving the offending amp further from your pickups is a possible solution as the pickups and the offending amp's field is the issue, not your DI-PREAMP.

SYMPTOM

NOISE (HIGH FREQUENCY HISS AND HASH) IN AUDIO

1. Defective instrument cable or problem with bass wiring. Plug a very short instrument cable into the instrument input (to turn the DI-PREAMP on), if hum is greatly reduced or eliminated, this means that the noise is entering from outside the DI-PREAMP. Try a known good instrument cable and/or bass).
2. Defective battery in active bass or DI-PREAMP causing excessive noise (replace battery).
3. If there is neon or fluorescent lighting close by, it's possible that EMI (electromagnetic interference) is radiating into the pick-up wiring. Arcing secondary wire on neon lighting or a failing ballast or tube on fluorescent lighting may be radiating EMI into instrument pick-up. Try turning off such lighting to see if noise goes away.
4. Disconnect audio feeds from the DI-PREAMP to the noisy equipment and see if the noise goes away. If it does not, the noise is being generated or introduced external to the DI-PREAMP.
5. Tweeter turned all the way up in a quiet room, especially if the sensitivity of the tweeter greatly exceeds that of the low frequency drivers. Turn tweeter down in these conditions.

SYMPTOM

NOISE (POPPING) IN AUDIO

1. Popping while playing, especially one string. Check bass set-up to be sure there is adequate clearances between the string and pickup pole pieces.
2. Popping while just sitting there, or when touched. Under dry environmental conditions, it's possible that electrostatic discharge is the cause. Try antistatic mat on floor or a humidifier in room.
3. Popping while moving cables or connectors indicates that there might be a defect in those cables or connectors. Replace cabling with known good and working cabling.

FACTORY SAMPLE SETTINGS

FUNK / FINGERSTYLE

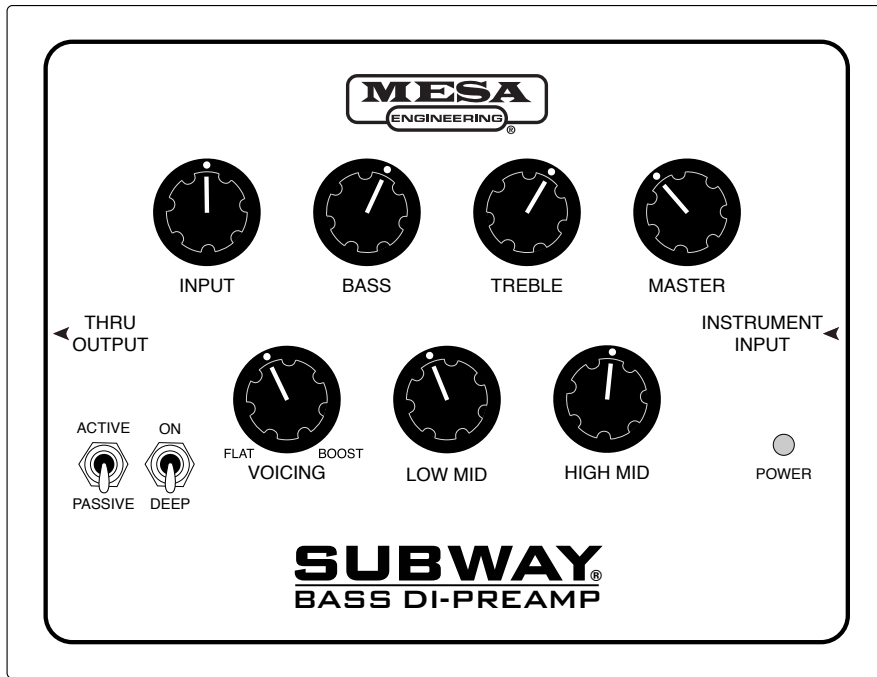

CLASSIC SLAP

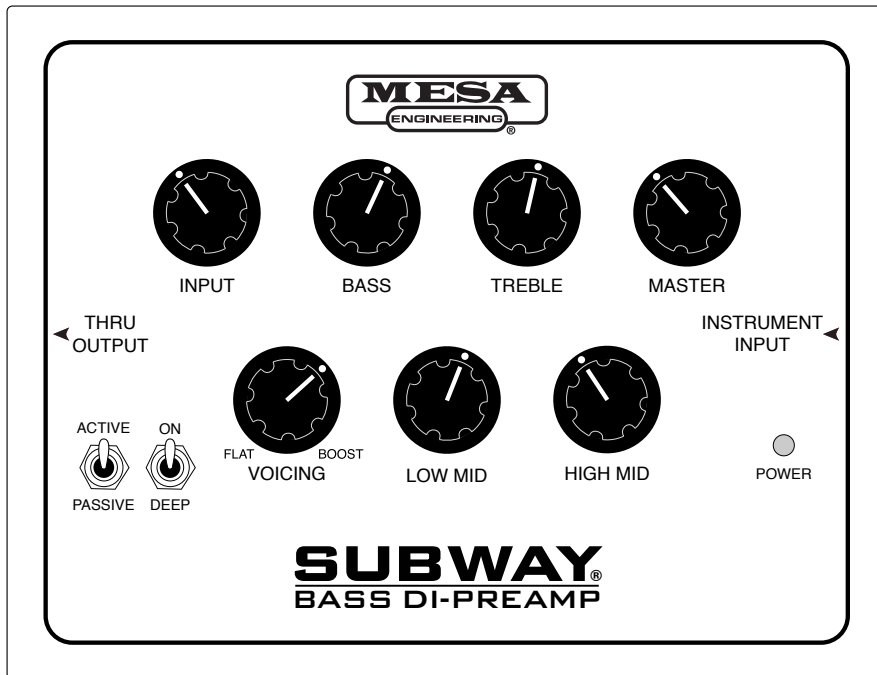

USER SETTINGS

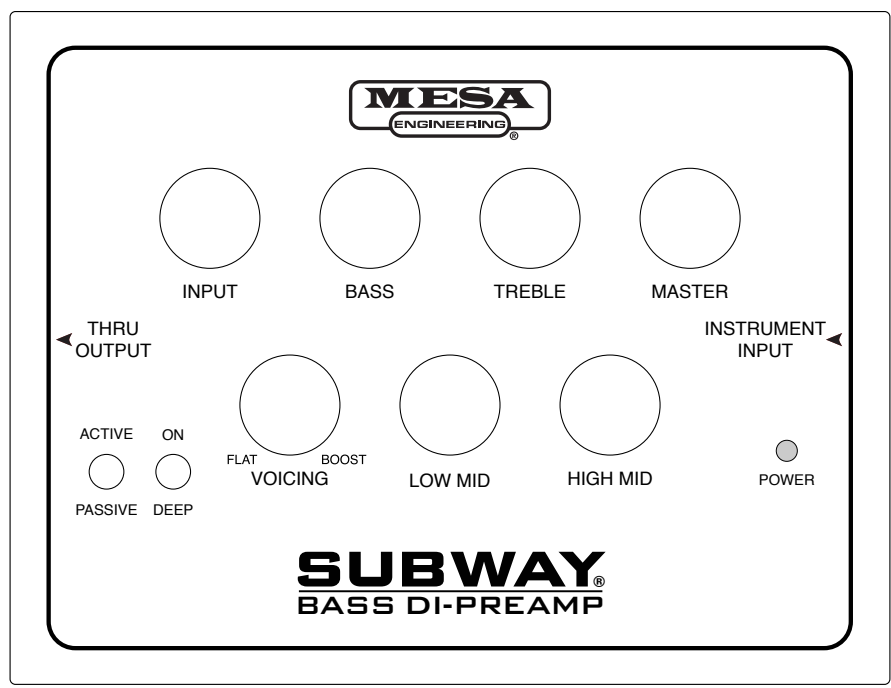

PLAYERS NOTES AND REMINDERS

A large rectangular area with rounded corners, containing ten horizontal lines for writing notes and reminders.

SUBWAY®

BASS DI-PREAMP

Specifications

Output Levels:		Nominal	Maximum	(nominal)
	Preamp Output (XLR balanced):	+4dBu	+12dBu	(line)
	Preamp Output (1/4" unbalanced):	0dBu	+6dBu	(line)
	DIRECT Output (XLR balanced):	-30dBu	-10dBu	(mic)
<hr/>				
Signal to Noise Ratio:	-78dB (20-20kHz, unweighted, battery operation)			
<hr/>				
Maximum Available Gain:	~45dB, (eq controls flat, passive mode, XLR preamp output))			
<hr/>				
High Pass Filter:	~30Hz, 4 pole, modified Butterworth alignment			
<hr/>				
Equalization:	Bass:	+14dB/-14dB @ 40Hz [note 1]		
	Low Mid:	+14dB/-14dB @ 200Hz		
	High Mid:	+14dB/-14dB @ 480Hz		
	Treble:	+11dB/-14dB @ 4kHz [note 1]		
<hr/>				
Power Requirements:	9 V alkaline battery or 9 VDC external power supply (2.1mm, center negative)			
Current draw:	~10mA average			
Battery Life:	~40 hours average			
<hr/>				
Size:	6.875" (175mm) wide x 5.27" (134mm) deep x 2.51" (64mm) high [note 2]			
<hr/>				
Weight:	Approx. 1.26 lbs (0.57 kg) [note 3]			

[note 1]: measured approx. 1 octave from knee

[note 2]: including feet and controls

[note 3]: not including battery

MESA/Boogie® continually develops new products and improves existing ones. For this reason, specifications and information in this manual are subject to change without notice.

SERVICE INFORMATION

- **USA /CANADA Customer Support:**

For technical support, troubleshooting, tone questions, settings help and more...

707-778-6565 Monday-Thursday, 9AM-5PM Pacific Time

NOTE: If a Product Specialist is not available when you call (helping other customers), PLEASE leave a voice message with a phone number and a good time to call and WE'LL CALL YOU BACK!

- **INTERNATIONAL Customer Support:**

For warranty and technical support, please contact your LOCAL MESA DISTRIBUTOR.

You may use this link to search the web for your local distributor's contact information:

www.mesaboogie.com/support/locations.html

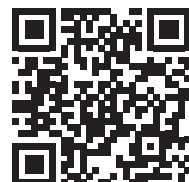

SUBWAY BASS DI-PREAMP BLOCK DIAGRAM

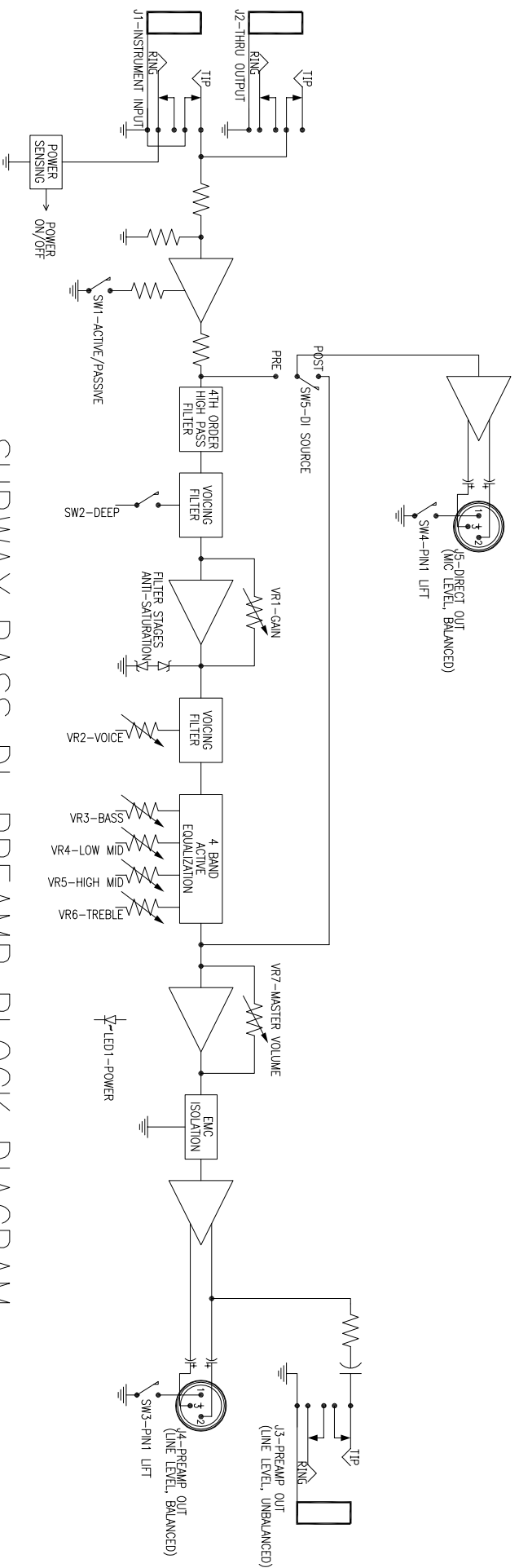

MESA/BOOGIE[®]

The Spirit of Art in Technology[™]

Thank you for trusting MESA/Boogie[®] to be your amplifier company and we wish you many years of toneful enjoyment from this handcrafted instrument.

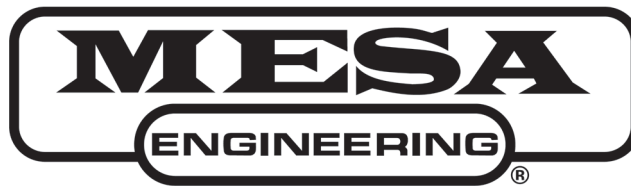

The Spirit of Art in Technology™



(707) 778-6565 FAX NO. (707) 765-1503
1317 Ross Street Petaluma, CA 94954
USA